

# Patrone Ceiling Spotlight Canopy

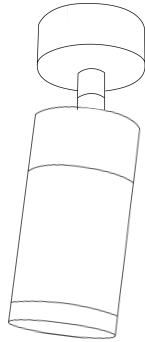

Installations Manual

We hope you will enjoy your new Patrone Lighting, designed by Kasper Thorup, and follow these instructions to ensure correct installation. For any questions, please contact us: [info@thorupcph.com](mailto:info@thorupcph.com)

Please read these instructions carefully to ensure that the product is used in accordance with its intended purpose only. For installation we advise you to consult a professionally qualified electrician.

Thorup Copenhagen is not responsible for any faults or damages caused by not following these instructions correctly. Do not modify this lamp in any way.

The lamps are crafted by local artisans in Copenhagen. Due to the hand-made process, each product is unique and variations may occur.

For indoor use only  
LED GU10 bulb (not included)  
Compatible with bulb of energy class A++  
3/35 Watts / Max 4/50 Watts

## Content

- Ceiling lamp fitted with canopy and wall bracket
- 2 x screws (For mounting the lamp with the wall bracket)
- 1 x Hex/Allen key (To tighten the pinol in canopy)
- White gloves (Wear the gloves when handling the untreated brass surface).

## Tools needed

- Bulb Type: LED GU10
- Electric drill / Screwdriver
- Screws and plugs appropriate for wall

## Safety Instructions

- Please read the instructions carefully before commencing assembly.
- Installation should be carried out in accordance with local safety regulations.
- Do not change the lightbulb while the fixture is switched on.
- The lamp is intended for indoor interior use only.
- In order to prevent damage, please check walls for cables before drilling holes.

## Mounting

Mounted directly to finished surface with the circular canopy. Standard configured as hard-wired to be installed directly, but can be re-configured to plug-in.

## Materials

**Untreated brass** is an honest material with an innate character that will gain natural, beautifying patina over time. The material will instantly oxidize when exposed to air, humidity and other external stimuli and brass discoloration will occur. This is not a flaw, but should be considered as unique characteristics of the natural and vivid material.

**The browned and black-browned** version has been undergoing a browning surface treatment, that enhances the look with a refined finish. Due to the individually, hand-made material treatment variations in the products may occur, making each item unique.

## Care & Maintenance

- This product is made from solid brass. For regular cleaning, use a soft, dry cloth without loose fibres.
- Do not use a sponge, polishing creams and/or cloths, chemical or abrasive cleaners and avoid using water.
- To keep the bright finish of the solid brass surface, we recommend cleaning the fixture with our Brass Care Kit. For more info on Care & Maintenance visit: [www.thorupcopenhagen.com](http://www.thorupcopenhagen.com)

CE □  IP20

## INSTALLATION INSTRUCTIONS

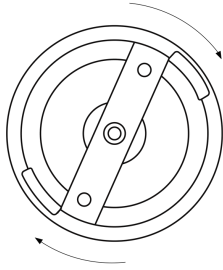

### Step 1

To unfasten the wall-bracket from the canopy carefully turn it clockwise until it is released.

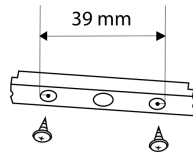

### Step 2

Drill the holes with a distance of 39 mm. for the bracket, and use the correct type of screw and plug for the type of wall. Tighten the screws and ensure the bracket is safely fixed in place.

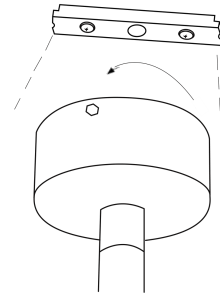

### Step 3

Place the canopy over the wall-bracket. Align the canopy on the bracket by carefully turning it anti-clockwise until it is fixed in place.

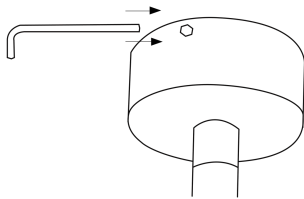

### Step 4

Carefully tighten the pinol with the included Hex / Allen key. Ensure not to over-tighten the pinol as it may cause damage to the product.

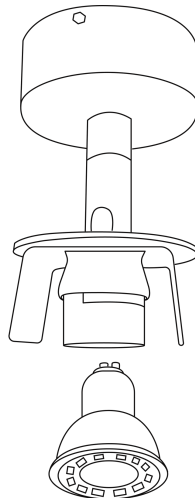

### Step 5

Install the LED bulb firmly by pushing it upwards and carefully turn clockwise until it is fixed in place. Compatible with standard LED GU10 bulbs.

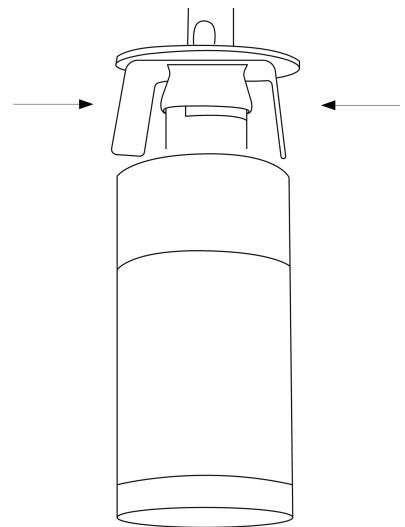

### Step 6

Install the shade, by gently pressing the two sides inwards to enclose the insert with the fixture. Use the flexible and rotational neck to set the shade at a desired angle. **Note:** Use the white gloves for the solid brass version.